



EN Operating instructions..... pages 7 to 12
Translation of the original operating instructions

FR Vous trouverez la version actuelle du mode d'emploi dans votre langue nationale officielle sur l'Internet, www.schmersal.net.

ES Encontrará el manual de instrucciones actual en su idioma oficial de la UE en nuestra página de Internet www.schmersal.net.

NL U vindt de huidige versie van de gebruikshandleiding in uw officiële landstaal op het Internet, www.schmersal.net.

IT Il manuale d'istruzioni aggiornato nella vostra lingua (lingua ufficiale UE) è scaricabile in Internet all'indirizzo www.schmersal.net.

JP EU公用語で書かれた最新の取扱説明書は、インターネット (www.schmersal.net) からダウンロードできます。

Content

1 About this document	
1.1 Function	1
1.2 Target group: authorised qualified personnel	1
1.3 Explanation of the symbols used	1
1.4 Appropriate use	1
1.5 General safety instructions	1
1.6 Warning about misuse	2
1.7 Exclusion of liability	2
2 Product description	
2.1 Ordering code	2
2.2 Special versions	2
2.3 Destination and use	2
2.4 Technical data	2
2.5 Safety classification	3
3 Mounting	
3.1 General mounting instructions	3
3.2 Dimensions	3
4 Electrical connection	
4.1 General information for electrical connection	3
5 Operating principle and settings	
6 Set-up and maintenance	
6.1 Functional testing	3
6.2 Maintenance	3
7 Disassembly and disposal	
7.1 Disassembly	3
7.2 Disposal	3
8 Appendix	
8.1 Wiring examples	4
8.2 Integral System Diagnostics (ISD)	5
8.3 Declaration of conformity	6

1 About this document

1.1 Function

This operating instructions manual provides all the information you need for the mounting, set-up and commissioning for the safe operation and disassembly of the safety-monitoring module. The operating instructions must be available in a legible condition and a complete version in the vicinity of the device.

1.2 Target group: authorised qualified personnel

All operations described in this operating instructions manual must be carried out by trained specialist personnel, authorised by the plant operator only.

Please make sure that you have read and understood these operating instructions and that you know all applicable legislations regarding occupational safety and accident prevention prior to installation and putting the component into operation.

The machine builder must carefully select the harmonised standards to be complied with as well as other technical specifications for the selection, mounting and integration of the components.

1.3 Explanation of the symbols used



Information, hint, note:

This symbol is used for identifying useful additional information.



Caution: Failure to comply with this warning notice could lead to failures or malfunctions.

Warning: Failure to comply with this warning notice could lead to physical injury and/or damage to the machine.

1.4 Appropriate use

The products described in these operating instructions are developed to execute safety-related functions as part of an entire plant or machine. It is the responsibility of the manufacturer of a machine or plant to ensure the proper functionality of the entire machinery or plant.

The safety-monitoring module must be exclusively used in accordance with the versions listed below or for the applications authorised by the manufacturer. Detailed information regarding the range of applications can be found in the chapter "Product description".

1.5 General safety instructions

The user must observe the safety instructions in this operating instructions manual, the country-specific installation standards as well as all prevailing safety regulations and accident prevention rules.



Further technical information can be found in the Schmersal catalogues or in the online catalogue on the Internet: www.schmersal.net.

The information contained in this operating instructions manual is provided without liability. Subject to technical modifications.



The entire concept of the control system, in which the safety component is integrated, must be validated to EN ISO 13849-2.

There are no residual risks, provided that the safety instructions as well as the instructions regarding mounting, commissioning, operation and maintenance are observed.

1.6 Warning about misuse



In case of inadequate or improper use or manipulations of the safety-monitoring module, personal hazards or damages to machinery or plant components cannot be excluded. The relevant requirements of the standard EN 1088 must be observed.

1.7 Exclusion of liability

We shall accept no liability for damages and malfunctions resulting from defective mounting or failure to comply with this operating instructions manual. The manufacturer shall accept no liability for damages resulting from the use of unauthorised spare parts or accessories.

For safety reasons, invasive work on the device as well as arbitrary repairs, conversions and modifications to the device are strictly forbidden; the manufacturer shall accept no liability for damages resulting from such invasive work, arbitrary repairs, conversions and/or modifications to the device.

2 Product description

2.1 Ordering code

This operating instructions manual applies to the following types:

AES 2①5②		
No.	Option	Description
①	3	3 enabling paths
	5	5 enabling paths
②	5	without start-up test
	6	with start-up test

AES 2①6②		
No.	Option	Description
①	3	3 enabling paths
	5	5 enabling paths
②	5	without start-up test
	6	with start-up test



Only if the information described in this operating instructions manual are realised correctly, the safety function and therefore the compliance with the Machinery Directive is maintained.

2.2 Special versions

For special versions, which are not listed in the order code below 2.1, these specifications apply accordingly, provided that they correspond to the standard version.

2.3 Destination and use

The safety-monitoring modules for integration in safety circuits are designed for fitting in control cabinets. They are used for the safe evaluation of the signals of positive break position switches for safety functions or magnetic safety sensors on sliding, hinged and removable safety guards as well as emergency stop control devices.

Design

The safety-monitoring modules have a dual-channel structure. They include two safety relays with monitored positive action contacts. The NO contacts of the relays, which are wired in series, build the enabling contacts.

2.4 Technical data

Standards:	IEC/EN 60204-1; EN 60947-5-1; EN 60947-5-3; EN ISO 13849-1; IEC 61508; BG-GS-ET-14; BG-GS-ET-20
Start conditions	Automatic or start button
Feedback circuit available:	yes
Start-up test:	AES ...5: no; AES ...6: yes
Pull-in delay for automatic start:	adjustable 0.1 / 1.0 second
Drop-out delay in case of emergency stop:	50 ms
Rated operating voltage U_e :	24 ... 230 VAC/DC
Rated operating current I_e :	0.3 A
Rated insulation voltage U_i :	250 V
Rated impulse withstand voltage U_{imp} :	4 kV
Thermal test current I_{the} :	6 A
Internal electronic fuse:	no
Power consumption:	5 W
Input monitoring:	
Cross-wire short detection:	yes
Wire breakage detection:	yes
Earth leakage detection:	yes
Number of NC contacts:	2
Number of NO contacts:	2
Outputs:	
Stop category 0:	AES 2355/6, AES 2365/6: 3 AES 2555/6, AES 2565/6: 4
Stop category 1:	0
Number of safety contacts:	AES 2355/6, AES 2365/6: 3 AES 2555/6, AES 2565/6: 4
Number of auxiliary contacts:	AES 2355/6, AES 2365/6: 0 AES 2555/6, AES 2565/6: 1
Number of signalling outputs:	2
Signalling output:	2 transistor outputs, Y1 + Y2 = max. 100 mA, p-type, short-circuit proof
Max. switching capacity of the safety contacts:	6 A
Utilisation category to EN 60947-5-1:	AC-15: 230 V / 3 A DC-13: 24 V / 2 A
Max. fuse rating:	6 A gG D-fuse
Mechanical life:	20 million operations
LED indication:	Wiring diagram
Ambient conditions:	
Operating temperature:	0°C ... +55°C
Storage and transport temperature:	-25°C ... +70°C
Protection class:	Enclosure: IP 40 Terminals: IP 20 Wiring compartment: IP 54
Degree of pollution:	2
Fixation:	Snaps onto standard DIN rails to DIN EN 60715
Connection type:	Screw terminals
Min. cable section:	0.2 mm ²
Max. cable section:	2.5 mm ² , solid strand or multi-strand lead (including conductor ferrules)
Tightening torque:	0.6 Nm
Max. cable length:	1000 m with 0.75 mm ² cable
Weight:	AES 2355/6, AES 2365/6: 290 g AES 2555/6, AES 2565/6: 300 g
Dimensions (H/W/D):	100 x 45 x 121 mm

2.5 Safety classification

Standards:	EN ISO 13849-1; IEC 61508
PL:	up to d
Control category:	up to 3
PFH value:	1.0 x 10 ⁻⁷ / h; applicable for applications with up to max. 50,000 switching cycles / year and max. 80 % contact load. Diverging applications upon request.
SIL:	up to 2
Service life:	20 years

3 Mounting

3.1 General mounting instructions

Mounting: snaps onto standard DIN rails to EN 60715.

3.2 Dimensions

Device dimensions (H/W/D): 100 x 45 x 121 mm

4 Electrical connection

4.1 General information for electrical connection



The electrical connection may only be carried out by authorised personnel in a de-energised condition.

Wiring examples: see appendix

5 Operating principle and settings

AES 2355/2356 and AES 2555/2556

Monitoring of two safety switches, which are simultaneously actuated by a safety guard (e.g. safety guard, diversitary actuation). Monitoring of one or multiple safety guards in series-/parallel-wiring only possible with a AES 2355/2356 and AES 2555/2556 series safety-monitoring module. The number of connected safety switches is restricted by the contact transition resistance and the conduction resistance. This overall resistance must not exceed 300 Ω. For magnetic safety sensors with LED, the brightness of the LED's reduce as the amount of guard doors opened increases.

AES 2365/2366 and AES 2565/2566

Monitoring of safety switches, which are actuated by different safety guards (e.g. two guard doors, which are opened independently from one another).

Operating principle after the operating voltage is switched on Without start-up test AES 2355 / 2555 / 2365 / 2565

1. The function of the safety-monitoring module is tested.
2. If the safety guard is closed, the enabling path of the safety-monitoring module will close. The LED is green.
3. The cable and the connected safety switch are only tested when the safety guard is opened or the emergency stop button when actuated.

With start-up test AES 2356 / 2556 / 2366 / 2566

1. The function of the safety-monitoring module is tested.
2. The safety guard must be actuated, in order to check the cables and the connected safety switch (start-up test).
3. If the safety guard is closed, the enabling path of the safety-monitoring module will close. The LED is green.

If the safety guard is opened, the enabling path of the safety-monitoring module will open. The machine is stopped and the LED flashes yellow. This contact however must not be integrated in the safety circuit.

Inputs S1-S14/S22; S2-S14/S22

Safety switches with one NC and one NO contact must be connected to the inputs S1/S2.

Feedback circuit X1/X2

Connect the feedback circuit of the external contactor with positive action contacts and/or a start button to the inputs X1 and X2 or bridge the inputs X1 and X2.

Enable delay time X7/X8

By bridging the connections X7/X8, the enable delay time (i.e. time during which after the first closing of the guard, bouncing of the switch contacts or of the entire guard is possible without error message) can be extended from 0.1 s to 1 s. The enable delay time simultaneously is the minimum time, expiring between the guard being closed and the relays being activated.

Outputs

Enabling paths 13-14, 23-24, 33-34, (43-44)

NO contacts for safety functions

Additional contact 51-52

NC contact for signalling purposes

Additional outputs Y1/Y2

Y1: indication "guard open"
Y2: indication "error"

The additional outputs Y1 and Y2 must not be integrated in the safety circuit; they may only be used for signalling purposes.

6 Set-up and maintenance

6.1 Functional testing

The safety function of the safety-monitoring module must be tested.

The following conditions must be previously checked and met:

1. Correct fitting of the safety-monitoring module
2. Fitting and integrity of the power cable

6.2 Maintenance

In the case of correct installation and adequate use, the safety-monitoring module features maintenance-free functionality.

A regular visual inspection and functional test, including the following steps, is recommended:

- Check the correct fixing of the safety monitoring module
- Check the cable for damage.

Damaged or defective components must be replaced.

7 Disassembly and disposal

7.1 Disassembly

The safety monitoring module must be disassembled in the de-energised condition only.

7.2 Disposal

The safety monitoring module must be disposed of in an appropriate manner in accordance with the national prescriptions and legislations.

8 Appendix

8.1 Wiring examples

The application examples shown are suggestions. They however do not release the user from carefully checking whether the switchgear and its set-up are suitable for the individual application.

The wiring diagram is shown with guard doors closed and in a de-energised condition. Inductive loads (e.g. contactors, relays, etc.) are to be provided with suitable interference suppression circuitry. Do not connect additional loads to terminal S.

AES 2355/2356/2555/2556

Monitoring of safety guards by means of magnetic safety sensors (BNS)
Contacts 43/44 and 51/55 not available for AES 2355 / 2356

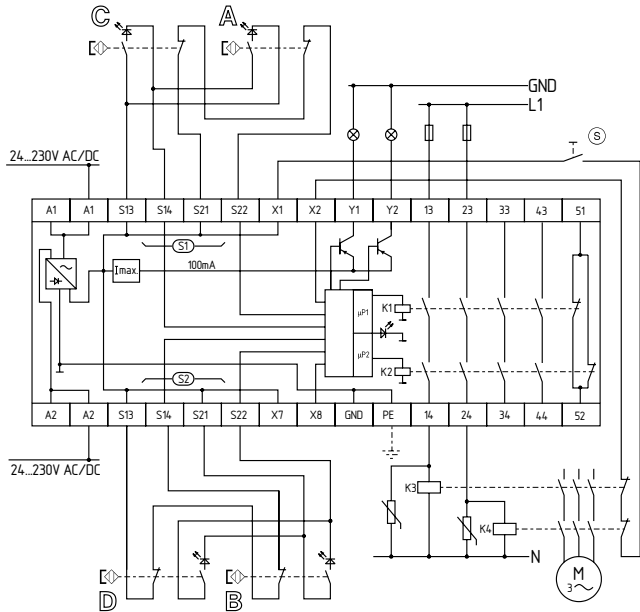

AES 2565 / 2566

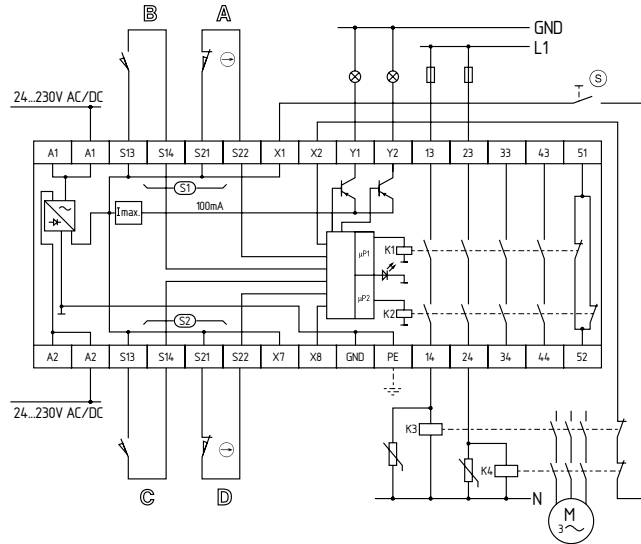

Legend

- ⊖ Positive break
- A - D Safety switch
- ⊞ Non-contact safety sensor
- Ⓢ Start button

AES 2365 / 2366

Monitoring of two independent safety guards by means of magnetic safety sensors (BNS)

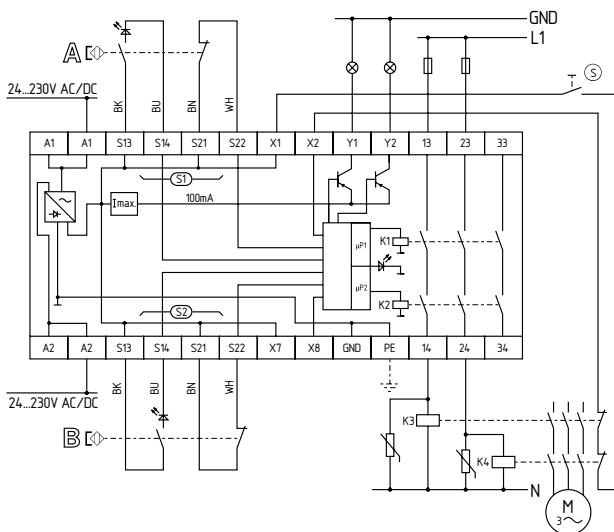

8.2 Integral System Diagnostics (ISD)

The LED indication of the safety-monitoring modules shows the different switching conditions and errors. The switching conditions are explained in the following tables.

Tables switching condition indication

Diagnostic LED	System condition
The LED is green.	Enabling paths closed
LED flashes yellow (0.5 Hz)	Enabling paths open
LED flashes yellow (2 Hz)	Safety guard closed, however no release; possible causes: incorrect operation (only one contact actuated upon opening) or voltage drop → perform start-up test

The safety-monitoring modules have two more LED indications. The yellow LED is intermittently on. The switching conditions are explained in the following tables.









Indication (yellow) LED	System condition
1 impulse 	Safety guard 1 open
2 impulses 	Safety guard 2 open

Table error indications



Indication (orange) LED	Error	Cause
1 impulse 	Inputs S1	Defective supply voltage lead, defective switch, erroneous fitting of the switch; switch only partially actuated for at least 5 s
2 impulses 	Inputs S2	Refer to errors inputs S1
3 impulses 	Inputs S1 and S2	Refer to errors inputs S1
4 impulses 	Interference signals at the inputs (no safe evaluation assured)	Too high capacitive or inductive interference at the switch's cables or the supply voltage lead
5 impulses 	One or both relays did not close within the monitoring time	Too low operating voltage U _e ; Defective relay
6 impulses 	Relay not disabled upon the actuation of the switch	Relay contact welding
7 impulses 	Dynamic monitoring of both channels (cross-monitoring) failure	Fault in one channel; internal data transmission interrupted

* Partial actuation: position of the switch, in which only one contact was actuated.

Deleting the error message

The error message is deleted, when the error cause is eliminated and the AES can check all functions. In case of an error of switch 1 or switch 2, actuate the switch concerned (open the safety guard and close it again). For all other errors, both switches must be actuated.

8.3 Declaration of conformity

	
<h2>EC Declaration of conformity</h2>	
Translation of the original declaration of conformity valid as of December 29, 2009	K.A. Schmersal GmbH Industrielle Sicherheitssysteme Möddinghofe 30, D - 42279 Wuppertal Germany Internet: www.schmersal.com
We hereby certify that the hereafter described safety components both in its basic design and construction conforms to the applicable European Directives.	
Name of the safety component / type:	AES 2355 / 2356 AES 2555 / 2556 AES 2365 / 2366 AES 2565 / 2566
Description of the safety component:	Safety-monitoring module for non-contact safety switches and safety relay combination in connection with the BNS series magnetic safety switches
Harmonised EC-Directives:	2006/42/EC EC-Machinery Directive 2004/108/EC EMC-Directive
Person authorized for the compilation of the technical documentation:	Ulrich Loss Möddinghofe 30 42279 Wuppertal
Notified body, which approved the full quality assurance system, referred to in Appendix X, 2006/42/EC:	TÜV Rheinland Industrie Service GmbH Alboinstrasse 56 12103 Berlin ID n°: 0035
Place and date of issue:	Wuppertal, October 7, 2009
AES 2355-B-EN	 Authorised signature Heinz Schmersal Managing Director



Note

The currently valid declaration of conformity can be downloaded from the internet at www.schmersal.net.



K. A. Schmersal GmbH
Industrielle Sicherheitssysteme
Möddinghofe 30, D - 42279 Wuppertal
Postfach 24 02 63, D - 42232 Wuppertal

Phone: +49 - (0)2 02 - 64 74 - 0
Telefax +49 - (0)2 02 - 64 74 - 1 00
E-Mail: info@schmersal.com
Internet: <http://www.schmersal.com>